

assonometria

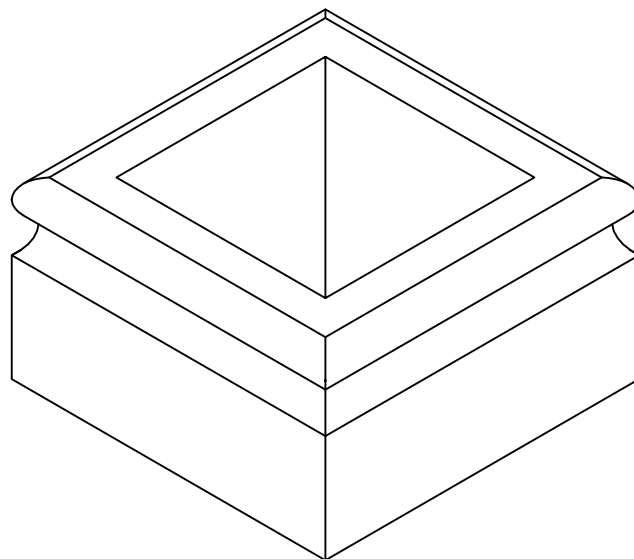

peso 40 kg

pianta

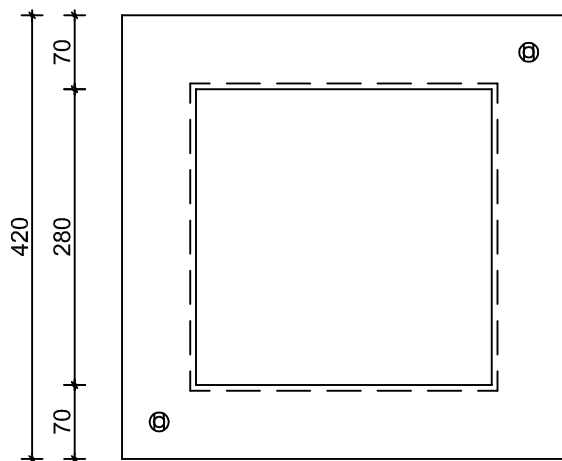

prospetto

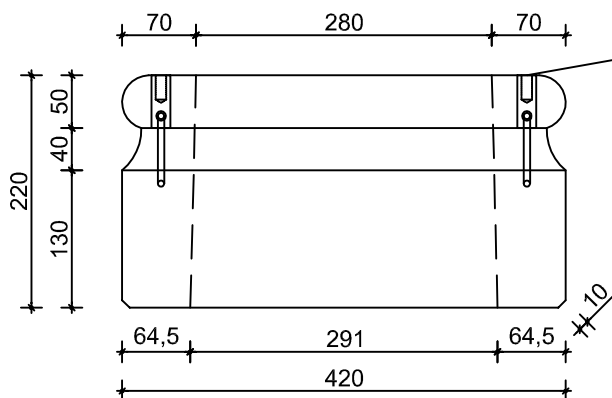

bocole Ø 10 mm per il sollevamento

ferro Ø 8 mm per l'ancoraggio boccole
zincato zigrinato

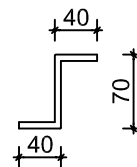

oggetto: art. MON-BASE-02 - BASE PILASTRO

rev.: 01-12

data: 30-04-2012

tavola: 01

misure in: mm